

Overview Infinity® 19" Industrial PC

<p>96M15831</p> 	<p>1 HE, 3 slots</p> <ul style="list-style-type: none"> • Drive bays: 1 x 5.25", 2 x 3.5" • Dimensions (WxDxH): 430 x 450 x 44 mm 	<ul style="list-style-type: none"> • Intel® <ul style="list-style-type: none"> - Core™ 2 Duo - Pentium® M 	<p>Page 42</p>
<p>96M1584D</p> 	<p>2 HE, 6 slots</p> <ul style="list-style-type: none"> • Drive bays: 1 x 5.25", 2 x 3.5", 3 x 2.5" • Dimensions (WxDxH): 434 x 453 x 88 mm 	<ul style="list-style-type: none"> • Intel <ul style="list-style-type: none"> - Core™ 2 Duo - Pentium® 4 / M 	<p>Page 44</p> 
<p>96M15801</p> 	<p>4 HE, 14 slots</p> <ul style="list-style-type: none"> • Drive bays: 3 x 5.25", 1 x 3.5" • Dimensions (WxDxH): 440 x 455 x 177 mm 	<ul style="list-style-type: none"> • Intel® <ul style="list-style-type: none"> - Core™ 2 Duo - Pentium® 4 / M 	<p>Page 46</p>  
<p>96M1574</p> 	<p>4 HE, 14 slots</p> <ul style="list-style-type: none"> • Drive bays: 4 x 5.25", 1 x 3.5" • Dimensions (WxDxH): 440 x 510 x 177 mm 	<ul style="list-style-type: none"> • Intel® <ul style="list-style-type: none"> - Core™ 2 Duo - Pentium® 4 / M 	<p>Page 48</p>  
<p>96M1588</p> 	<p>4 HE, 14 slots (front)</p> <ul style="list-style-type: none"> • Drive bays: 1 x 5.25", 3 x 3.5" • Dimensions (WxDxH): 440 x 503 x 177 mm 	<ul style="list-style-type: none"> • Intel® <ul style="list-style-type: none"> - Core™ 2 Duo - Pentium® 4 / M 	<p>Page 50</p>
<p>96M1593</p> 	<p>3 HE, 7 slots, ATX</p> <ul style="list-style-type: none"> • Drive bays: 2 x 5.25", 4 x 3.5" • Dimensions (WxDxH): 440 x 462 x 133 mm 	<ul style="list-style-type: none"> • Intel® <ul style="list-style-type: none"> - Pentium® 4 	<p>Page 52</p>
<p>96M1594</p> 	<p>4 HE, 7 slots, ATX</p> <ul style="list-style-type: none"> • Drive bays: 4 x 5.25", 1 x 3.5" • Dimensions (WxDxH): 440 x 510 x 177 mm 	<ul style="list-style-type: none"> • Intel® <ul style="list-style-type: none"> - Core™ 2 Duo - Pentium® 4 	<p>Page 54</p> 
<p>96M1591</p> 	<p>4 HE, 7 slots, ATX</p> <ul style="list-style-type: none"> • Drive bays: 3 x 5.25", 1 x 3.5" • Dimensions (WxDxH): 440 x 455 x 177 mm 	<ul style="list-style-type: none"> • Intel® <ul style="list-style-type: none"> - Pentium® 4 	<p>Page 56</p>

Infinity® 19" Industrial PC

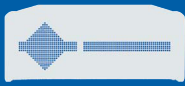

1 U



Infinity® 19"
Industrial PC

Configuration example Intel® Celeron® M

- with DSM SBC and **Intel® Celeron® M 1.3 GHz** processor (optional with Intel® Pentium® M 1.8 GHz)
- **512 MB** DDR RAM equipped, optional up to 2 GB
- int. Intel® 855GME AGP 4x, 64 MB shared memory
- Intel® 82562ET LAN, 10/100 Base-T/TX
- I/O: 2 x serial and 1 x parallel
- Controller for 2 x floppy and 4 x EIDE drives

- **80 GB** EIDE quality harddisk (or larger)
- 3.5" floppy disk drive, 1.44 MB, slimline
- 350 Watt power supply
- 3 slot backplane, 1 x PICMG, 1 x ISA, 1 x PCI (optional 3 slot backplane with 1 x PICMG, 2 x PCI)
- 2 years Warranty, Burn-In, CE compliant

Configuration example Intel® Core™ 2 Duo

- with DSM SBC and **Intel® Core™ 2 Duo 2.16 GHz** processor
- **1 GB** DDR2 RAM equipped, optional up to 4 GB (max. 3 GB for operating system)
- int. Intel® GMA 950 Graphic, PCI Express x16
- Intel® Dual 82573L GigaBit LAN, 10/100/1000 Base-T/TX
- I/O: 2 x serial and 1 x parallel
- Controller for 2 x floppy, 2 x EIDE drives and 2 x SATA drives

- int. Compact Flash socket, 2 x Mini-PCI slots
- **250 GB** SATA quality harddisk
- 3.5" floppy disk drive, 1.44 MB, slimline
- 350 Watt power supply (optional 400 Watt)
- 3 slot backplane, 1 x PICMG, 1 x ISA, 1 x PCI (optional 3 slot backplane with 1 x PICMG, 2 x PCI)
- 2 years Warranty, Burn-In, CE compliant

Custom configurations on request!



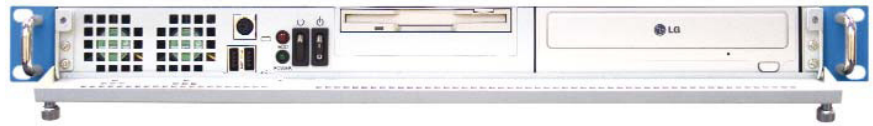
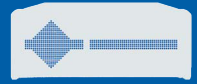

Front view (open)



Rear view

Layout 96M15831

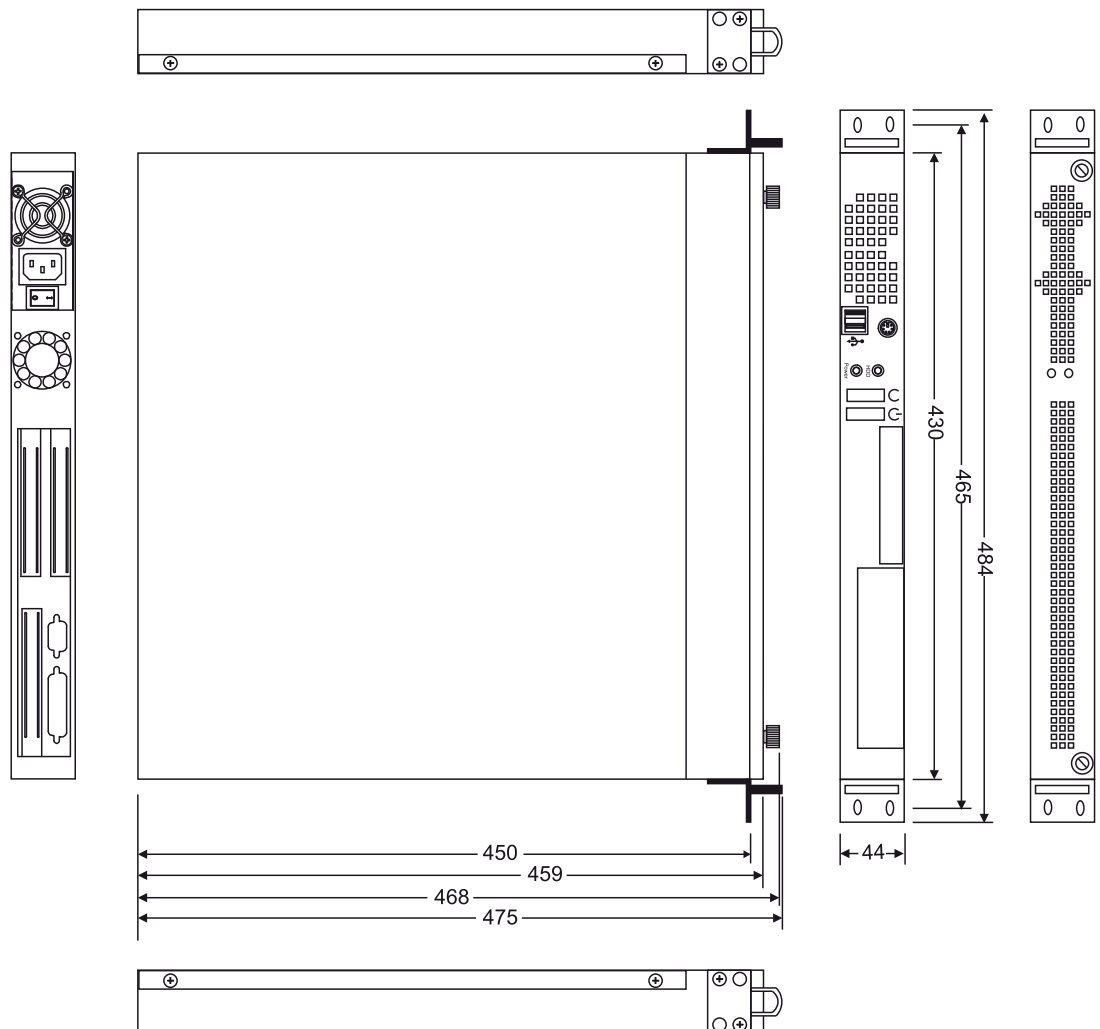

Infinity® 19" Industrial PC

General description

- flat high-quality 19" chassis for assembly in 19" rack or as desktop
- Chassis front optional **in all RAL and NCS colors available**
- on request also **with your corporate logo**
- Drive bays: 1 x 5.25" and 2 x 3.5" (1 x slimline ext., 1 x int.)
- 3 x 4 cm cooler fans (2 x front, 1 x back), optional Papst
- inclusive PCI bus expansion **still 1 free PCI or 1 free ISA slot** (optional 2 free PCI slots)
- Delivery with or without 19" angles
- Dimensions: WxDxH **430x450x44** mm



2 U



Infinity® 19" Industrial PC

Configuration example Intel® Pentium® 4

- with DSM SBC and **Intel® Pentium® 4 2.4 GHz** processor
- **256 MB** DDR RAM equipped, optional up to 2 GB
- int. AGP Controller, Intel® 82845G, 64 MB
- int. Intel® 82562 LAN, 10/100 Base-T/TX
- I/O: 2 x serial and 1 x parallel
- Controller for 2 x floppy and 4 x EIDE drives
- passive 6 slot ISA backplane or 6 slot PCI/ISA (4xPCI, 1xPCI/ISA, 1xISA)

- **80 GB** EIDE quality harddisk (or larger)
- **DVD-ROM** quality drive, ATAPI
- 3.5" floppy disk drive, 1.44 MB, TEAC
- 350 Watt power supply (optional 400 Watt)
- 6 slot PCI/ISA bus (4xPCI, 1xPCI/ISA, 1xISA)
- still **3 free PCI slots**
- 2 years Warranty, Burn-In, CE compliant

Configuration example Intel® Celeron® M - PICMG 1.3

- with DSM SBC and **Intel® Celeron® M 1.5 GHz** processor (optional Intel® Pentium® M up to 2.0 GHz)
- **512 MB** DDR2 RAM (SO-DIMM) equipped, opt. up to 2 GB
- int. Intel® 915GM GMA 900, shared memory
- Dual Marvell Yukon GigaBit LAN, 10/100/1000 Base-T/TX, PCIe
- I/O: 2 x serial and 1 x parallel
- PICMG 1.3 (PCI Express) 4 slot backplane
1 x PCI Express x1, 1 x PCI Express x16, 2 x PCI

- int. Compact Flash socket
- Controller for 2 x floppy, 2 x EIDE and 2 x SATA 150 drives
- **250 GB** SATA quality harddisk
- **DVD-ROM** quality drive, ATAPI
- 3.5" floppy disk drive, 1.44 MB, TEAC
- 350 Watt power supply (optional 400 Watt)
- Backplane inclusive 2 x SATA and 2 x USB
- 2 years Warranty, Burn-In, CE compliant

Configuration example Intel® Core™ 2 Duo

- with DSM SBC and **Intel® Core™ 2 Duo 2.16 GHz** processor
- **1 GB** DDR2 RAM equipped, optional up to 4 GB (max. 3 GB for operating system)
- int. Intel® GMA 950 Graphic, PCI Express x16
- Intel® Dual 82573L GigaBit LAN, 10/100/1000 Base-T/TX
- I/O: 2 x serial and 1 x parallel
- Controller for 2 x floppy, 2 x EIDE and 2 x SATA drives
- int. Compact Flash socket, 2 x Mini-PCI slot

- **250 GB** SATA quality harddisk
- **DVD-ROM** quality drive, ATAPI
- 3.5" floppy disk drive, 1.44 MB
- 350 Watt power supply (optional 400 Watt)
- 6 slot PCI/ISA bus (4xPCI, 1xPCI/ISA, 1xISA)
- still **3 free PCI slots**
- 2 years Warranty, Burn-In, CE compliant

Custom configurations on request!



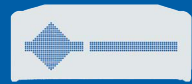

Front view (open)



Rear view

Layout
96M1584D

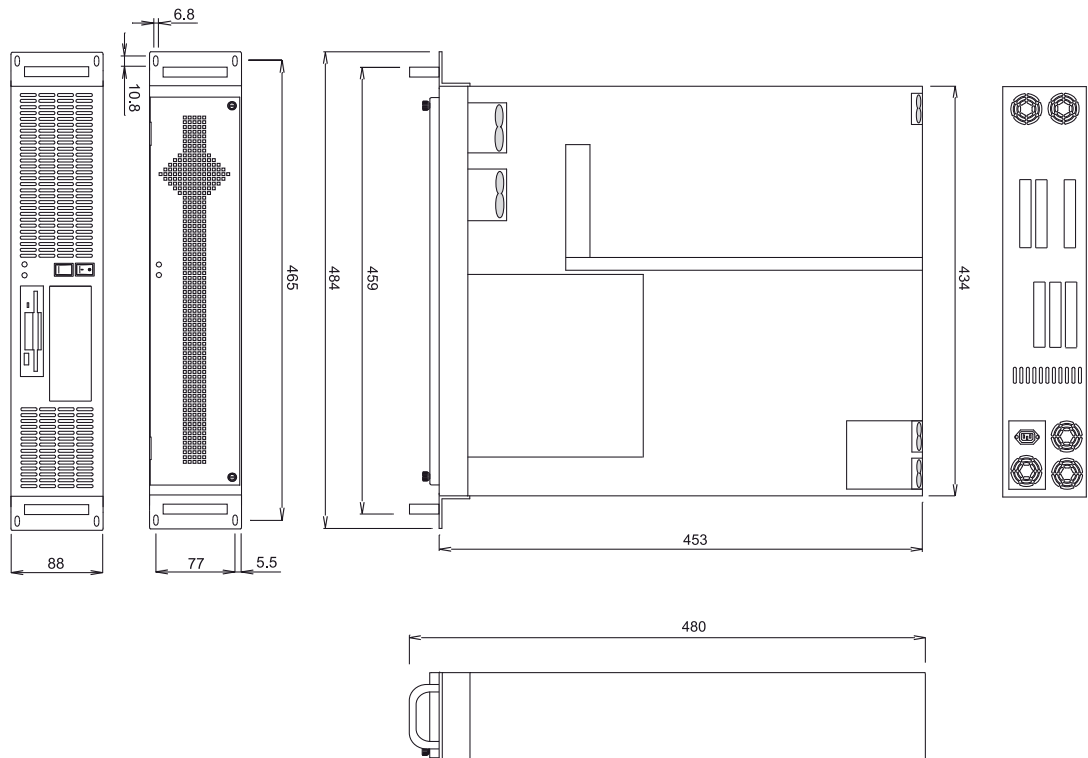

Infinity® 19" Industrial PC

General description

- flat high-quality 19" chassis for assembly in 19" rack or as desktop for heavy-duty applications
- Chassis light varnish, 19" angles optional **in all RAL and NCS colors available**
- on request also **with your corporate logo**
- Delivery with or without 19" angles
- Device bays 1 x 5.25", 2 x 3.5" and 3 x 2.5"
- 2 x 8 cm cooler fan behind filter (optional Papst)
- 1 x 6 cm cooler fan and 4 x 4 cm cooler fan
- 3 long and 3 short slots each
- Dimensions WxDxH **432x431x88 mm**

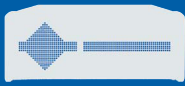

4 U



Infinity® 19" Industrial PC

Configuration example Intel® Celeron® M - Fanless

- with DSM SBC
- **Intel® Celeron® M (ULV) 1.0 GHz Fanless**
- **256 MB** DDR RAM equipped, optional up to 2 GB
- int. Intel® 855GME AGP 4x, 64 MB shared memory
- Dual Intel® 82562ET LAN, 10/100 Base-T/TX
- I/O: 2 x serial and 1 x parallel
- Controller for 2 x floppy and 4 x EIDE drives
- int. Compact Flash socket
- **80 GB** 2.5" EIDE quality harddisk (or larger)
- Floppy / CD/DVD-ROM via USB 2.0 ext. possible
- 300 Watt power supply
- 14 slot backplane, PCI/ISA
- still **8 free ISA and 4 free PCI slots**
- **Operating temperatures: 0° - +45°C** (without additional plug-in cards)
- 2 years Warranty, Burn-In, CE compliant

Configuration example Intel® Celeron® M - PICMG 1.3

- with DSM SBC and **Intel® Celeron® M 1.5 GHz** processor (optional Intel® Pentium® M up to 2.0 GHz)
- **512 MB** DDR2 RAM (SO-DIMM) equipped, opt. up to 2 GB
- int. Intel® 915GM GMA 900, shared memory
- Dual Marvell Yukon GigaBit LAN, 10/100/1000 Base-T/TX, PCIe
- I/O: 2 x serial and 1 x parallel
- Controller for 2 x floppy, 2 x EIDE and 2 x SATA 150 drives
- int. Compact Flash socket
- **250 GB** SATA quality harddisk
- **DVD-ROM** quality drive, 16-fold/52-fold ATAPI
- 3.5" floppy disk drive, 1.44 MB, TEAC
- 400 Watt power supply (optional 600 Watt)
- PICMG 1.3 (PCI Express) 13 slot backplane
3 x PCI Express x1, 1 x PCI Express x16, 8 x PCI
- Backplane inclusive 2 x SATA and 2 x USB
- powerful 12 cm cooler fan (optional Papst) behind filter
- 2 years Warranty, Burn-In
CE compliant

Configuration example Intel® Core™ 2 Duo

- with DSM SBC and **Intel® Core™ 2 Duo 2.16 GHz** processor
- **1 GB** DDR2 RAM equipped, optional up to 4 GB (max. 3 GB for operating system)
- int. Intel® GMA 950 Graphic, PCI Express x16
- Intel® Dual 82573L GigaBit LAN, 10/100/1000 Base-T/TX
- I/O: 2 x serial and 1 x parallel
- Controller for 2 x floppy, 2 x EIDE and 2 x SATA drives
- int. Compact Flash socket, 2 x Mini-PCI slot
- **250 GB** SATA quality harddisk
- **DVD-ROM** quality drive, ATAPI
- 3.5" floppy disk drive, 1.44 MB
- 400 Watt power supply
- 14 slot backplane, PCI/ISA
- still **8 free ISA and 4 free PCI slots**
- powerful 12 cm cooler fan (optional Papst) behind filter
- 2 years Warranty
Burn-In
CE compliant

Custom configurations on request!



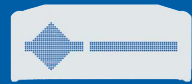

Front view (open)



Rear view

Layout
96M15801

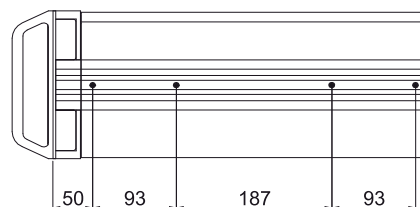
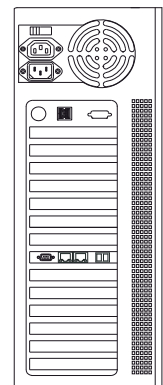
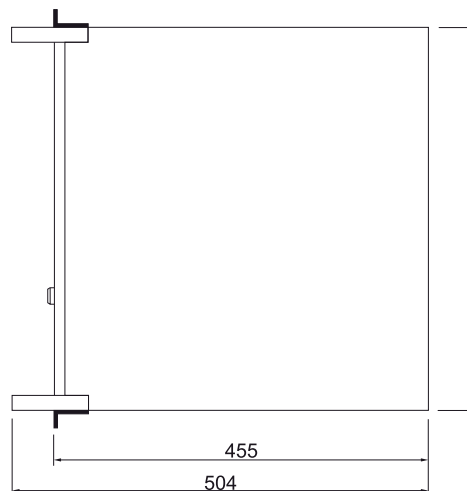
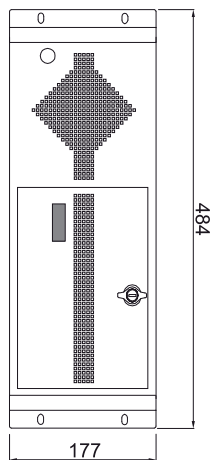
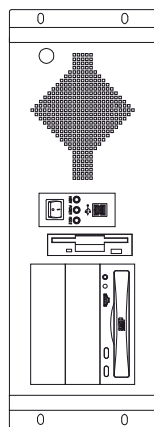

Infinity® 19"
Industrial PC

General description

- solid high-quality 19" chassis for assembly in 19" rack or as desktop for heavy-duty applications
- Chassis front optional **in all RAL and NCS colors available**
- on request also **with your corporate logo**
- Security crossbar with hold-down clamps
- Drive bays: 3 x 5.25" and 1 x 3.5"
- Device cage vibration-protected
- Delivery with or without 19" grips and angles
- Dimensions: WxDxH **440x455x177** mm

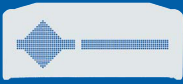

4 U



Infinity® 19" Industrial PC

Configuration example Intel® Pentium® 4

- with DSM SBC and **Intel® Pentium® 4 2.4 GHz** processor
- **256 MB** DDR RAM equipped, optional up to 2 GB
- int. AGP Controller, Intel® 82845G, 64 MB
- int. Intel® 82562 LAN, 10/100 Base-T/TX
- I/O: 2 x serial and 1 x parallel
- Controller for 2 x floppy and 4 x EIDE drives
- **80 GB** EIDE quality harddisk (or larger)
- **DVD-ROM** quality drive ATAPI
- 3.5" floppy disk drive, 1.44 MB, TEAC
- 350 Watt power supply (optional 400 Watt)
- 14 slot backplane, PCI/ISA
- still **8 free ISA and 4 free PCI slots**
- powerful cooler fan behind filter (optional Papst)
- 2 years Warranty, Burn-In, CE compliant

Configuration example Intel® Celeron® M - Fanless

- with DSM SBC
- **Intel® Celeron® M (ULV) 1.0 GHz Fanless**
- **256 MB** DDR RAM equipped, optional up to 2 GB
- int. Intel® 855GME AGP 4x, 64 MB shared memory
- Dual Intel® 82562ET LAN, 10/100 Base-T/TX
- I/O: 2 x serial and 1 x parallel
- Controller for 2 x floppy and 4 x EIDE drives
- **80 GB** 2.5" EIDE quality harddisk (or larger)
- Floppy / CD/DVD-ROM via USB 2.0 ext. possible
- 300 Watt power supply
- 14 slot backplane, PCI/ISA
- still **8 free ISA and 4 free PCI slots**
- **Operating temperatures: 0° - +45°C** (without additional plug-in cards)
- 2 years Warranty, Burn-In CE compliant

Configuration example Intel® Core™ 2 Duo

- with DSM SBC and **Intel® Core™ 2 Duo 2.16 GHz** processor
- **1 GB** DDR2 RAM equipped, optional up to 4 GB (max. 3 GB for operating system)
- int. Intel® GMA 950 Graphic, PCI Express x16
- Intel® Dual 82573L GigaBit LAN, 10/100/1000 Base-T/TX
- I/O: 2 x serial and 1 x parallel
- Controller for 2 x floppy, 2 x EIDE and 2 x SATA drives
- int. Compact Flash socket
- **250 GB** SATA quality harddisk
- **DVD-ROM** quality drive, ATAPI
- 3.5" floppy disk drive, 1.44 MB
- 400 Watt power supply
- 14 slot backplane, PCI/ISA
- still **8 free ISA and 4 free PCI slots**
- powerful cooler fan behind filter (optional Papst)
- 2 years Warranty, Burn-In, CE compliant

Custom configurations on request!



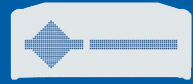

Front view (open)



FANLESS



Rear view

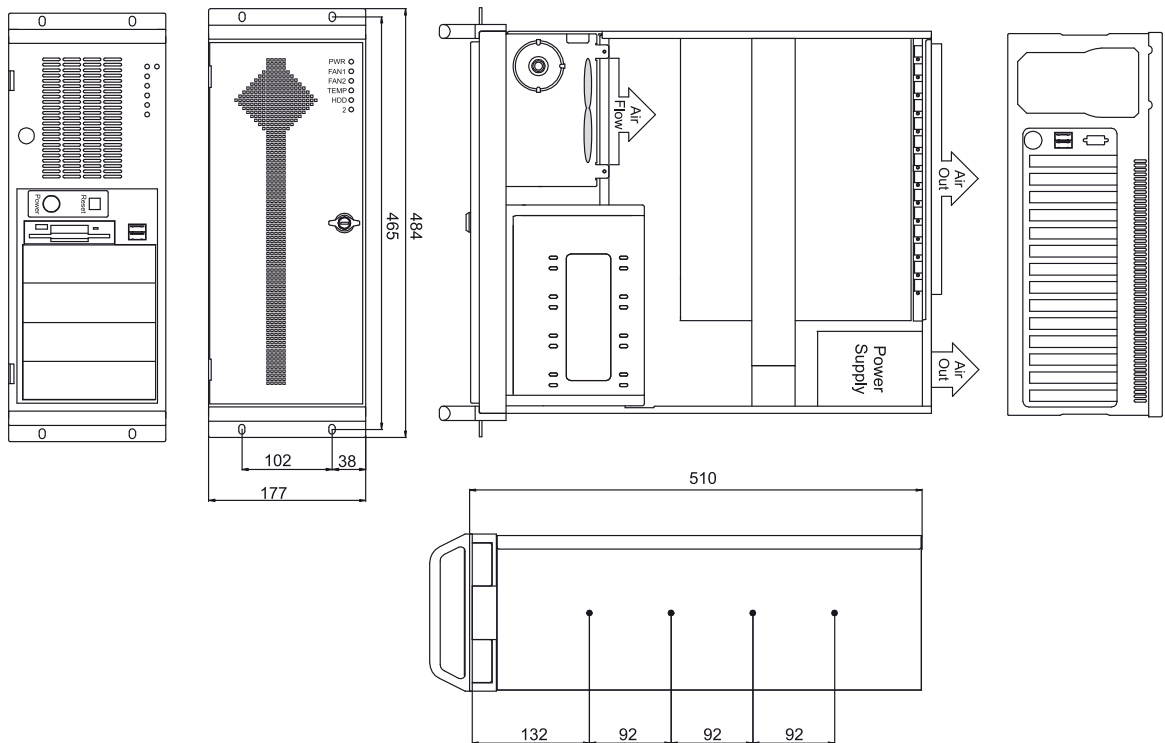

Layout 96M1574

Infinity® 19" Industrial PC

General description

- solid high-quality 19" chassis for assembly in 19" rack or as desktop for heavy-duty applications
- optional with Hardware Control / LEDs
- Chassis front optional
- **in all RAL and NCS colors available**
- on request also with **your corporate logo**
- Security crossbar with hold-down clamps
- Drive bays: **4 x 5.25"**, **1 x 3.5"**
- opt. RAID SATA hard drive mobile rack e.g. for 3 drives, 3 in 2 (2 x 5.25" bays used)
- Device cage vibration-protected, rubber mounted
- passive backplane with 14 ISA or PCI/ISA slots opt. max. 14 ISA or 4-12 PCI slots
- 8 long and 6 short slots each
- Delivery with or without 19" grips and angles
- Dimensions: WxDxH **440x510x177** mm

4 U



Infinity® 19" Industrial PC

Configuration example Intel® Pentium® 4

- with DSM SBC and **Intel® Pentium® 4 2.4 GHz** processor
- **256 MB** DDR RAM equipped, optional up to 2 GB
- int. AGP Controller, Intel® 82845G, 64 MB
- int. Intel® 82562 LAN, 10/100 Base-T/TX
- I/O: 2 x serial and 1 x parallel
- Controller for 2 x floppy and 4 x EIDE drives
- **80 GB** EIDE quality harddisk (or larger)

- **DVD-ROM** quality drive, ATAPI
- 3.5" floppy disk drive, 1.44 MB, TEAC
- 350 Watt power supply (optional 400 Watt)
- 14 slot backplane, PCI/ISA
- still **8 free ISA and 4 free PCI slots**
- 2 years Warranty, Burn-In CE compliant

Configuration example Intel® Core™ 2 Duo

- with DSM SBC and **Intel® Core™ 2 Duo 2.16 GHz** processor
- **1 GB** DDR2 RAM equipped, optional up to 4 GB (max. 3 GB for operating system)
- int. Intel® GMA 950 Graphic, PCI Express x16
- Intel® Dual 82573L GigaBit LAN, 10/100/1000 Base-T/TX
- I/O: 2 x serial and 1 x parallel
- Controller for 2 x floppy, 2 x EIDE and 2 x SATA drives
- int. Compact Flash socket, 2 x Mini-PCI slot

- **250 GB** SATA quality harddisk
- **DVD-ROM** quality drive, ATAPI
- 3.5" floppy-disk drive, 1.44 MB
- 400 Watt power supply
- 14 slot backplane, PCI/ISA
- still **8 free ISA and 4 free PCI slots**
- 2 years Warranty, Burn-In CE compliant

Custom configurations on request!



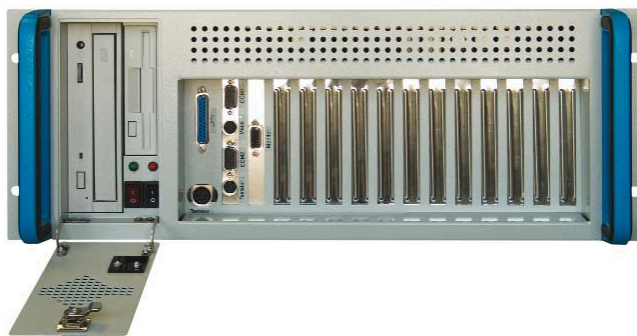
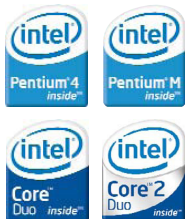

Front view (open)



Rear view

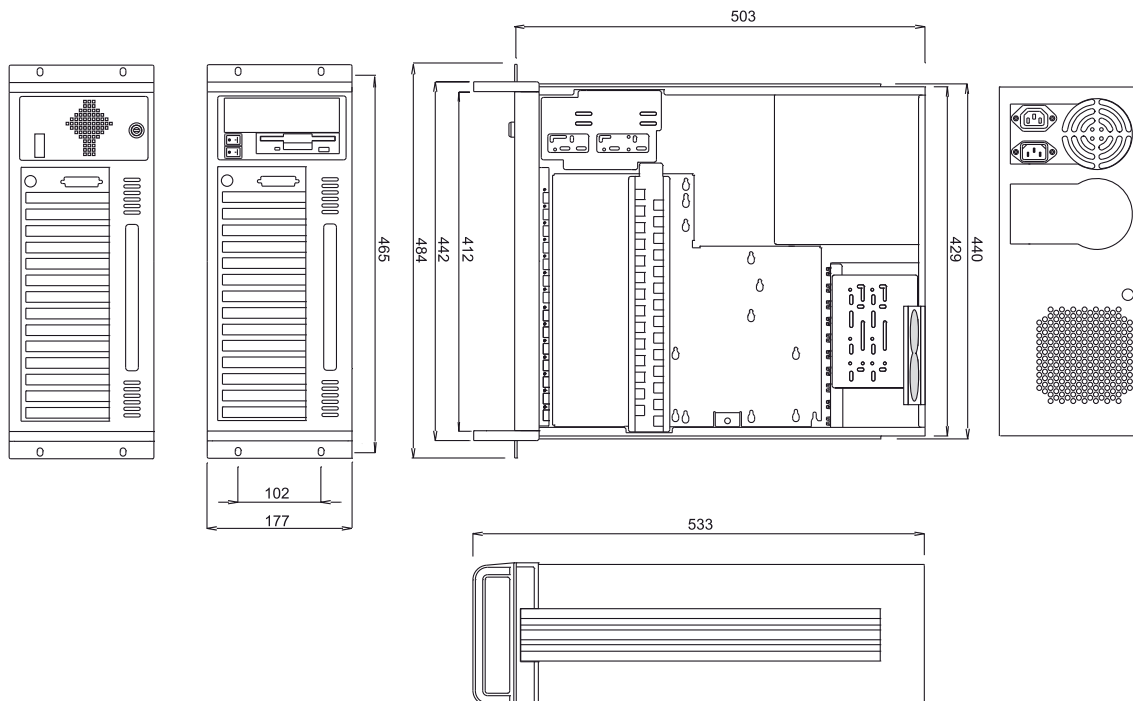

Layout
96M1588

Infinity® 19" Industrial PC

General description

- solid high-quality 19" chassis for assembly in 19" rack or as desktop for heavy-duty applications
- Chassis light varnish, angles and 19" grips optional **in all RAL and NCS colors available**
- on request also **with your corporate logo**
- Security crossbar with hold-down clamps
- Drive bays: 1 x 5.25" and 3 x 3.5"
- powerful 12 cm cooler fan (optional Papst)
- passive backplane with 14 ISA or PCI/ISA slots optional max. 14 ISA or 4-12 PCI slots
- **The rear panels of the max. 14 cards are easily accessible from the front**
- all 14 slots in full length (388 mm) accessible
- Delivery with or without 19" grips and angles
- Dimensions: WxDxH **440x499x177** mm



3 U

**Technical specifications****CPU**

- Intel® Pentium® 4 / Celeron® up to 2.8 GHz
- Intel® Pentium® 4 M up to 2.2 GHz
- 400/533 MHz FSB, socket 478

Chipset

- Intel® 845GV

Memory

- 2 DIMM slots, up to 2 GB
- DDR 266/333 SDRAM

Graphic

- Intel® 82845G (GMCH) AGP with 64 MB shared memory

Audio

- Realtek ALC655 Audio Controller, AC' 97, 5.1 CH

LAN

- Intel® 82562ET Controller with 10/100 Mbit/s
- full duplex, 1 x RJ45 port

IDE

- supports 4 enhanced IDE drives, ultra DMA/33/66/100

FDD

- up to 2 drives for
360 KB / 720 KB / 1.44 MB / 1.2 MB / 2.88 MB

BIOS

- Award BIOS in Flash-ROM

Environment

- solid high-quality 19" chassis for assembly in 19" rack or as desktop for use in heavy-duty environment

Ports

- 4 x USB (2.0), opt. 6 x USB (2.0)
- 2 x PS/2, 1 x LAN, 1 x VGA
- 2 x COM (RS-232), opt. 4 x COM (2 x RS-232/422/485)
- 1 x LPT, Audio (Line-In, Line-Out, Mic)

Case

- Front optionally in all RAL and RSC colors available
- on request also with your corporate logo
- Security crossbar with hold-down clamps

Slots

- 6 x PCI (32Bit, 33 MHz, 5V), long

Device bays

- 2 x 5.25" and 4 x 3.5" (for floppy disk, CD-ROMs, DVD-ROMs, harddisk etc.)

Cooler fan

- 2 ball bearing 8 cm cooler fans (optional Papst) behind filter (front)

Operating elements

- behind lockable metal door (inclusive drives)
- Power switch and reset button in the front

Power supply

- 350 Watt

Dimensions

- WxDxH: 440x462x133 mm

2 years Warranty**Burn-In****CE compliant**



4 U

**Technical specifications****CPU**

- Intel® Core™ 2 Duo, LGA775, 1066/800 MHz FSB
- Intel® Pentium® 4, LGA775, 800/533 MHz FSB
- Intel® Celeron® D, LGA775, 533 MHz FSB
- supports Hyper-Threading Technology

Chipset

- Intel® 945G

Memory

- 4 DIMM slots, max. 4 GB (max. 3 GB for operating system)
- DDR2 667/533/400 SDRAM
- single/dual channel, unbuffered, no ECC

Graphic

- Intel® Graphic Media Accelerator 950
- up to 2048 x 1536, 75 Hz
- Intel® Dynamic Video Memory Technology

Audio

- Realtek ALC262 (HD Audio), 2 channels

LAN

- Broadcom BCM5751 Controller with 10/100/1000 Mbit/s
- full duplex, 1 x RJ45 port, PCIe

Serial ATA Interface

- 4 serial ATA II 300 ports, up to 4 drives
- RAID 0, 1, 0+1, 5

IDE

- supports 2 enhanced IDE drives, ultra DMA/33/66/100

FDD

- supports 2 drives for
360 KB / 720 KB / 1.44 MB / 1.2 MB / 2.88 MB

BIOS

- Phoenix BIOS in Flash-ROM

Slots

- 1 x PCI Express x16, 2 x PCI Express x1
- 4 x PCI (32Bit, 33 MHz, 5V), long

Environment

- solid high-quality 19" chassis for assembly in 19" rack or as desktop for use in heavy-duty environment

Ports

- 8 x USB (2.0), 2 x PS/2, 2 x COM, LPT, Audio, LAN, VGA

Cooler fan

- ball bearing 12 cm cooler fan behind filter (front), temperature controlled, optional Papst
- ball bearing 6 cm cooler fan (back), optional Papst

Case

- Front optionally in all RAL and RSC colors available
- on request also with your corporate logo
- Security crossbar with hold-down clamps
- Delivery with or without 19" grips and angles

Device bays

- 4 x 5.25" and 1 x 3.5" (for floppy disk drive, CD-ROMs, DVD-ROMs, harddisk etc.)
- Optional RAID SATA hard drive mobile rack e.g. for 3 drives, 3 in 2 (2 x 5.25" bays used)
- Device cage vibration-protected, rubber mounted

Operating elements

- behind lockable metal door inclusive drives
- Power switch, reset button and USB (2x) in the front

Software

- supports Windows XP (SP1a required) / 2000 (SP4 required)

Power Supply

- 400 Watt (max. 550 Watt), optional redundant

Dimensions

- WxDxH: 440x510x177 mm

2 years Warranty**Burn-In****CE compliant**

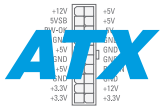
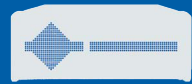

Front view (open)



Rear view

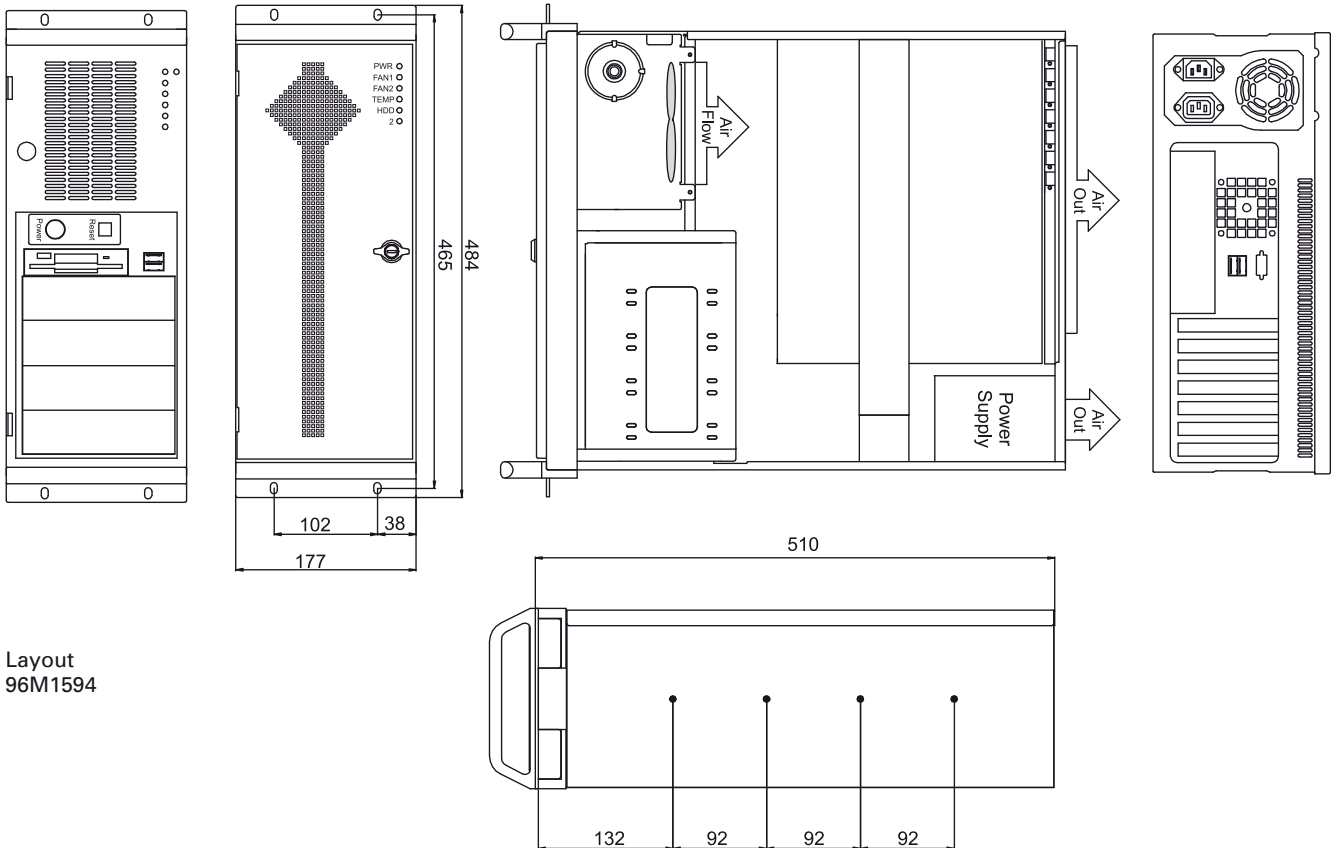
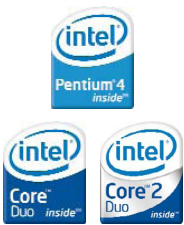

Layout 96M1594

Infinity® 19" Industrial PC

Custom configurations on request!



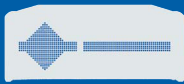

4 U

**Technical specifications****CPU**

- Intel® Pentium® 4 / Celeron® up to 2.8 GHz
- Intel® Pentium® 4 M up to 2.2 GHz
- 400/533 MHz FSB, socket 478

Chipset

- Intel® 845GV

Memory

- 2 DIMM slots, up to 2 GB
- DDR 266/333 SDRAM

Graphic

- Intel® 82845G (GMCH) AGP with 64 MB shared memory

Audio

- Realtek ALC655 Audio Controller, AC' 97, 5.1 CH

LAN

- Intel® 82562ET Controller with 10/100 Mbit/s
- full duplex, 1 x RJ45 port

IDE

- supports 4 enhanced IDE drives, ultra DMA/33/66/100

FDD

- supports 2 drives for
360 KB / 720 KB / 1.44 MB / 1.2 MB / 2.88 MB

BIOS

- Award BIOS in Flash-ROM

Environment

- solid high-quality 19" chassis for assembly in 19" rack or as desktop for use in heavy-duty environment

Ports

- 4 x USB (2.0), optional 6 x USB (2.0)
- 2 x PS/2, 1 x LAN, 1 x VGA
- 1 x COM (RS-232), optional 4 x COM (2 x RS-232/422/485)
- 1 x LPT, Audio (Line-In, Line-Out, Mic)

Case

- Front optionally in all RAL and RSC colors available
- on request also with your corporate logo
- Security crossbar with hold-down clamps
- Delivery with or without 19" angles and grips

Slots

- 6 x PCI (32Bit, 33 MHz, 5V), long

Device bays

- 3 x 5.25" and 1 x 3.5" (for floppy disk drive, CD-ROM, DVD-ROM, harddisk etc.)
- Device cage vibration-protected

Cooler fan

- Powerful 12 cm cooler fan (optional Papst) behind removable filter

Operating elements

- behind lockable metal door inclusive drives
- Power switch and reset button in the front

Power supply

- 400 Watt, optional 600 Watt or redundant power supply

Dimensions

- WxDxH: 440x455x177 mm

2 years Warranty, Burn-In, CE compliant

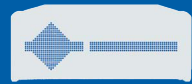

Front view (open)



Rear view

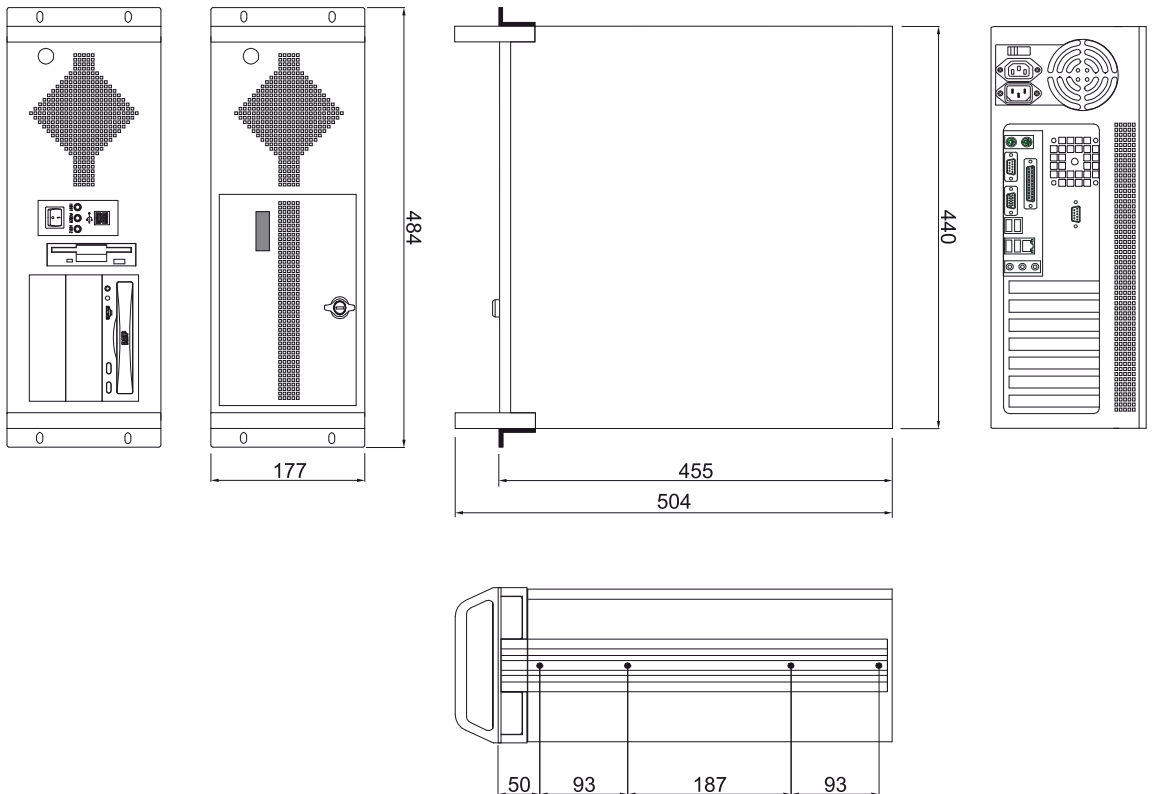

Layout
96M1591

Infinity® 19"
Industrial PC

Custom configurations on request!

