



Overview BookSize PC

NEW

BookSize B6



- Slots: 1 x PCI
- Drives: 1 x 3.5"/2.5" HDD (EIDE or SATA 150) or 2 x Compact Flash
- int. 60 Watt power supply AC
- Operating temperatures: 0° - 50° C
- Dimensions (WxDxH): 300 x 220 x 90 mm

- Intel®
 - Core™ Duo
 - Core™ 2 Duo
 - Celeron® M

Page 28

NEW

BookSize B2



- Slots: 1 x PCI
- Drives: 1 x 3.5"/2.5" HDD EIDE or 2 x Compact Flash
- int. 60 Watt power supply AC
- Operating temperatures: 0° - 45° C
- Dimensions (WxDxH): 300 x 220 x 90 mm

- Intel®
 - Celeron® M
 - Pentium® M

Page 30

NEW

BookSize B1



- Slots: 1 x PCI
- Drives: 1 x 3.5"/2.5" HDD (EIDE or SATA 150) or 2 x Compact Flash
- int. 60 Watt power supply AC
- Operating temperatures: 0° - 50° C
- Dimensions (WxDxH): 300 x 220 x 90 mm

- VIA
 - C7

Page 32



BookSize PC

BookSize B6



NEW

Technical specifications

Embedded Controller

- up to 4 GB DDR2 RAM (max. 3 GB for operating system), 667 MHz, 0 MB equipped
- Intel® 82945GM chipset
- 1 x 10/100 Base-TX LAN, Intel® ICH-7M
- 1 x 1000 Base-T LAN, Marvell 88E8053 PCI Express
- optional Wireless LAN 802.11b/g
- Intel® GMA 950 VGA, with 224 MB shared memory, max. resolution 2048 x 1536 @ 75 Hz, S-VIDEO and Composite TV-Out
- Audio Controller, AC'97, S/PDIF and Line-Out
- Serial ATA for 2 SATA 150 drives
- Controller with one IDE port (2 x EIDE drives)
- optional Disk-on-Module or Compact Flash
- IEEE 1394 TI TSB43LV22 1 port FireWire
- 6 x USB 2.0, PS/2 port (2x), 2 x COM
- 1 x Mini-PCI slot (int.), type IIIA

**1 x PCI expansion slot for half-size cards
Floppy via USB 2.0 ext. possible**

**Drive bay for: 1 x 3.5"/2.5" HDD (EIDE or SATA 150) or
2 x Compact Flash**

solid high-quality industrial case

- Case in all RAL and NCS colors available
- on request also with your corporate logo
- one 6 cm sytem cooler fan, temperature controlled
- optional mounting rails
- Control LEDs
- Power supply: - int. 60 Watt power supply, 100-240 Volt AC
- optional 24 Volt DC, 50 Watt
- Dimensions WxDxH: 300 x 220 x 90 mm

2 years Warranty, Burn-In, CE compliant

96M1458

DSM "BookSize B6"

- Intel® Core™ 2 Duo T7400 2.16 with cooler fan (optional Intel® Core™ Duo T2500, 2.0 GHz)
- **Operating temperatures: 0° - +50°C**

Custom configurations on request!





BookSize PC

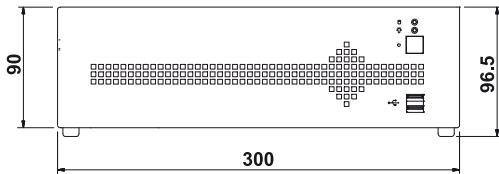
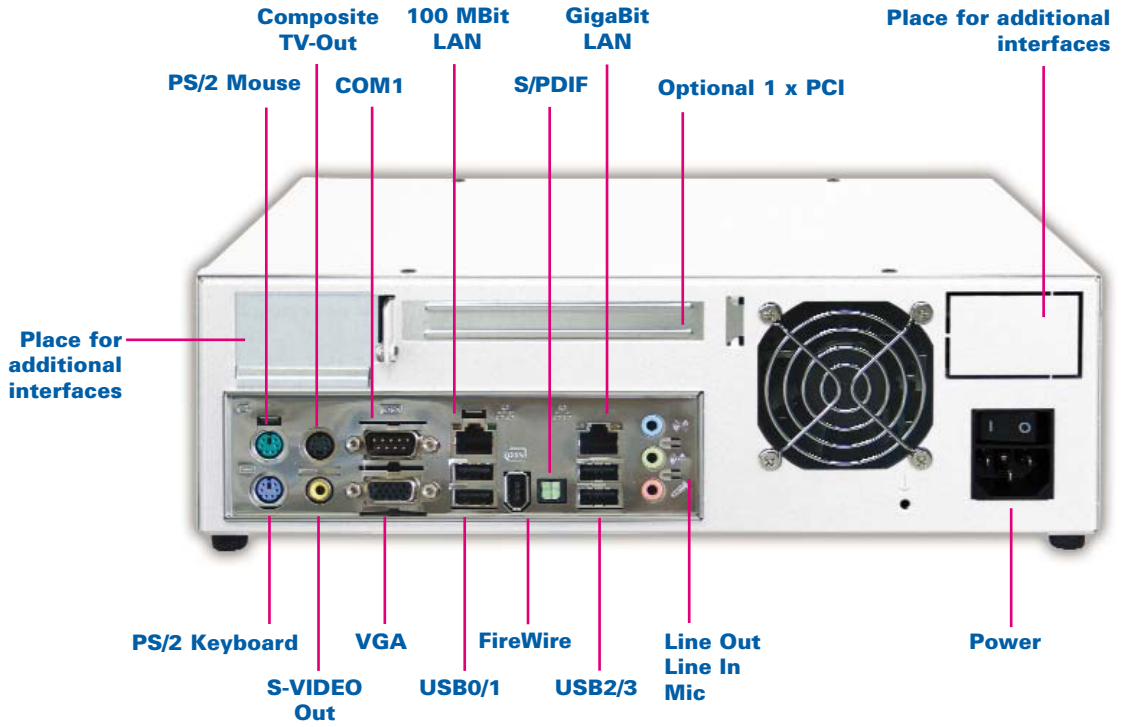
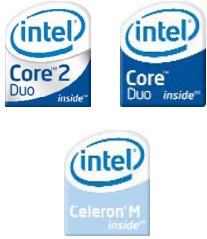

Layout 96M1458



optional assembly in switchboard possible

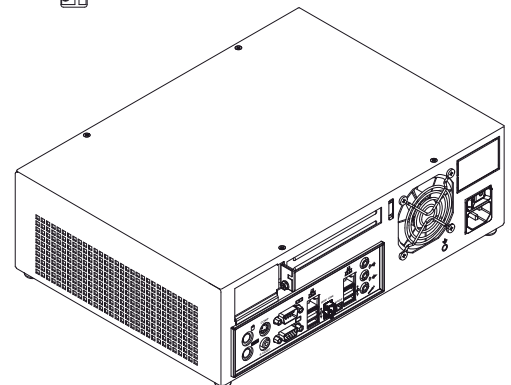
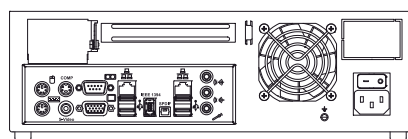
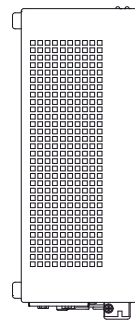
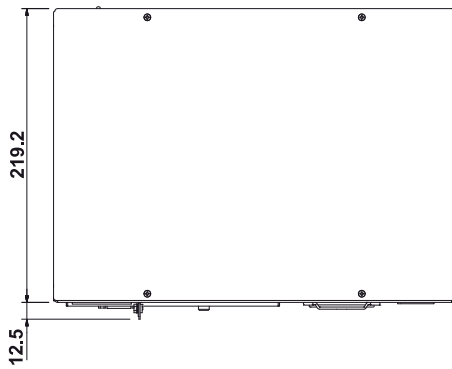
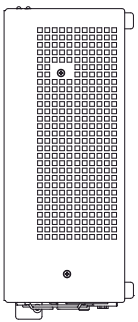

BookSize PC



BookSize PC

BookSize B2



NEW

BookSize PC

Technical specifications

Embedded Controller

- up to 1 GB DDR RAM, PC200/266/333, 0 MB equipped
- Intel® Extreme Graphics 2 VGA Controller, with 64 MB shared memory, MPEG2 Decoder, max. resolution 1600 x 1200 @ 85 Hz
- Controller with 2 IDE ports (4 x EIDE drives)
- optional Disk-on-Module or Compact Flash
- DVI-I Monitor connector (optional VGA connector)
- Intel® ICH4 Audio Controller, AC'97
- 4 x USB 2.0, PS/2 port (2x), 2 x COM, 1 x LPT
- 1 x Mini-PCI slot (int.), type IIIA
- optional Wireless LAN 802.11b/g

1 x PCI expansion slot for half-size cards
Floppy via USB 2.0 ext. possible

**Drive bay for: 1 x 3.5"/2.5" HDD EIDE or
 2 x Compact Flash**

Solid high-quality industrial case

- Case in all RAL and NCS colors available
- On request also with your corporate logo
- one 6 cm system cooler fan, temperature controlled
- optional mounting rails
- Control LEDs
- Power supply: - int. 60 Watt power supply, 100-240 Volt AC
 - optional 24 Volt DC, 50 Watt
- Dimensions WxDxH: 300 x 220 x 90 mm

2 years Warranty, Burn-In, CE compliant

96M1455CL DSM "BookSize B2"

- Intel® Celeron® M 600 MHz, without cooler fan
- Intel® 852GM chipset, 400 MHz FSB
- Intel® chipset int. LAN, 10/100 Base-T/TX
- **Operating temperatures: 0° - 45°C**

Custom configurations on request!





BookSize PC

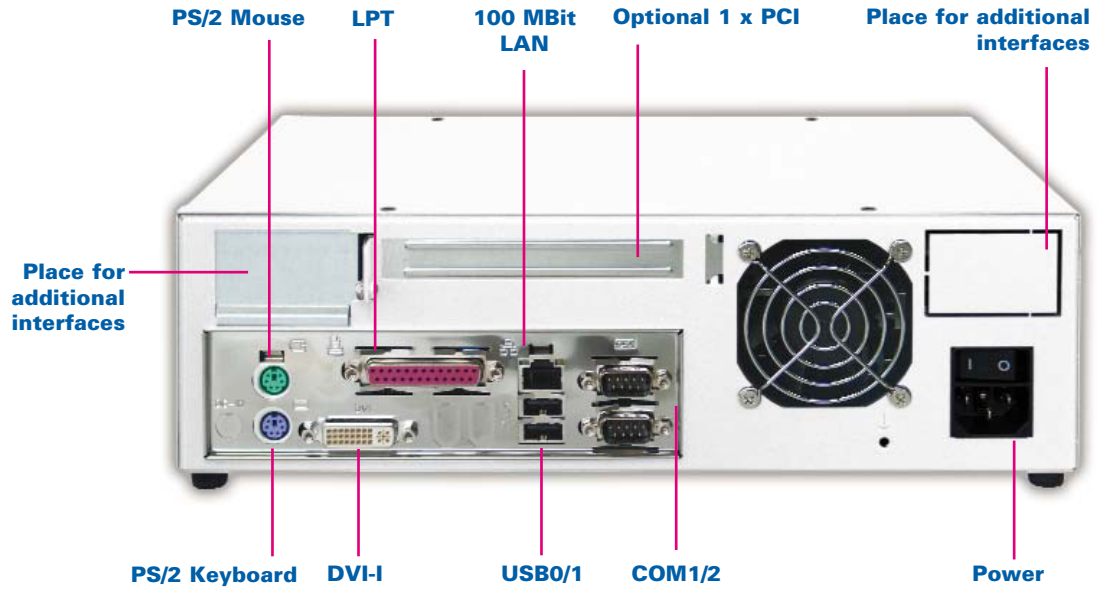

BookSize PC

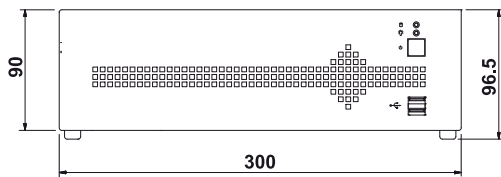

Layout 96M1455CL



optional assembly in switchboard possible

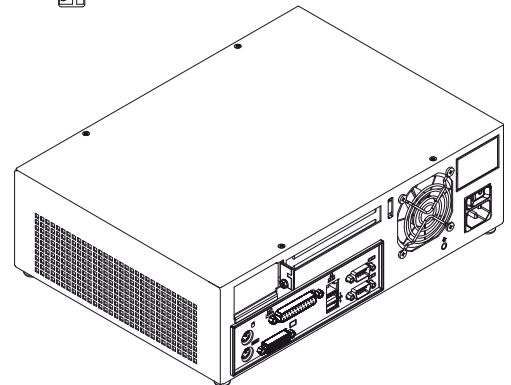
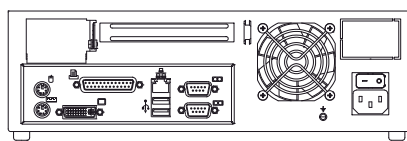
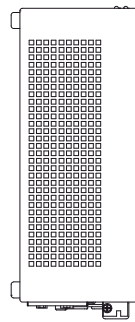
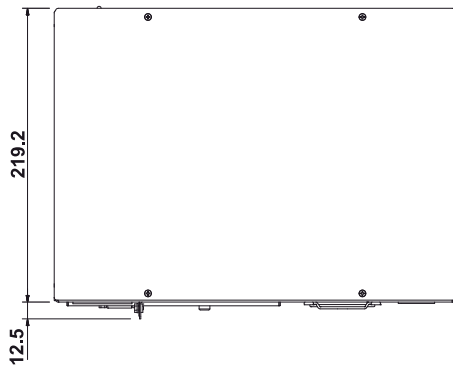
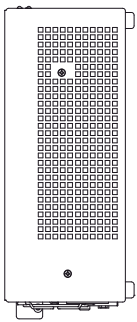



BookSize PC

BookSize B1



NEW

BookSize PC

Technical specifications

Embedded Controller

- up to 1 GB DDR2 RAM, 533 MHz, 0 MB equipped
- VIA CN700 chipset
- VIA 2D/3D VGA Controller, 64 MB shared memory, MPEG2-Decoder, S-VIDEO and Composite TV-Out
- Single LAN VIA VT6103, 10/100 Base-TX
- VIA Audio Controller, AC'97
- Controller with 2 IDE ports (4 x EIDE drives)
- Serial ATA for 2 SATA 150 drives
- optional Disk-on-Module or Compact Flash
- one serial port, PS/2 port (2x)
- 6 x USB 2.0

1 x PCI expansion slot for half-size cards
Floppy via USB 2.0 ext. possible

Drive bay for: 1 x 3.5"/2.5" HDD (EIDE or SATA 150) or 2 x Compact Flash

Solid high-quality industrial case

- Case in all RAL and NCS colors available
- on request also with your corporate logo
- one 6 cm sytem cooler fan, temperature controlled
- optional mounting rails
- Control LEDs
- Power supply: - int. 60 Watt power supply, 100-240 Volt AC
- optional 24 Volt DC, 50 Watt
- Dimensions WxDxH: 300 x 220 x 90 mm

2 years Warranty, Burn-In, CE compliant

96M1442F

DSM "BookSize B1"

- VIA C7 1.0 GHz processor, without cooler fan
- **Operating temperatures: 0° - +50°C**

Custom configurations on request!





BookSize PC

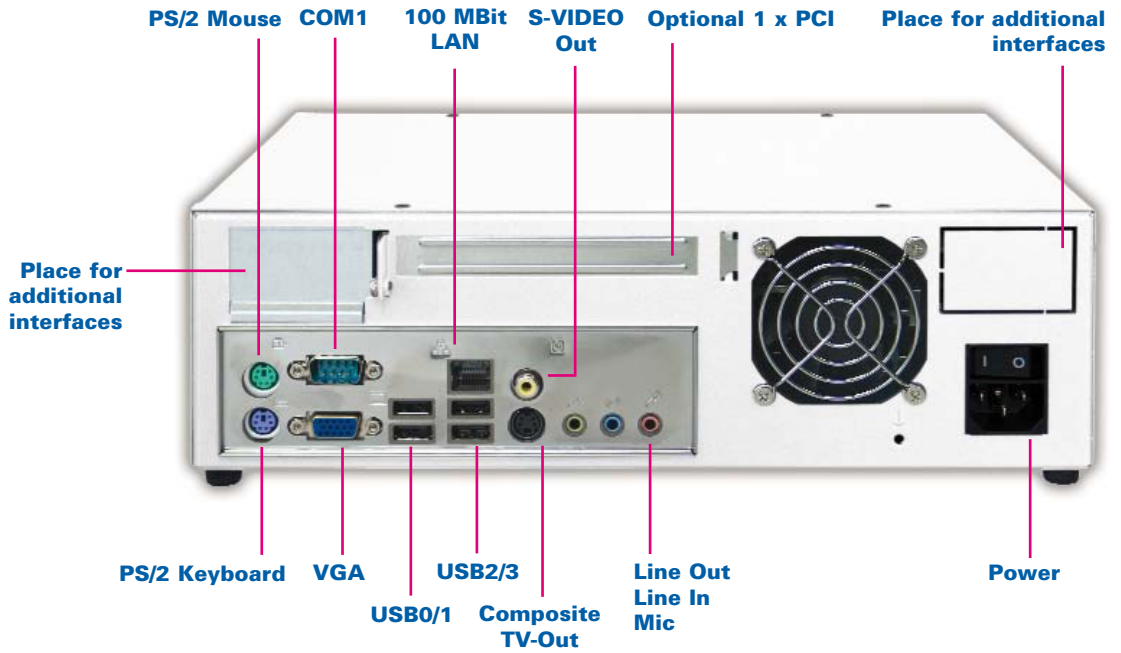

BookSize PC

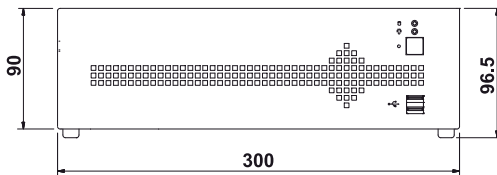

Layout 96M1442F



optional assembly in switchboard possible

